

How to Measure Tractor Covers

Measurement Instruction

- ✓ Give exact measurement from edge to edge.
- ✓ We add 0.5" to 1.5" leeway on the given width/depth for easy pull-in and pull-out.
- ✓ The height dimensions will remain same as provided by you.

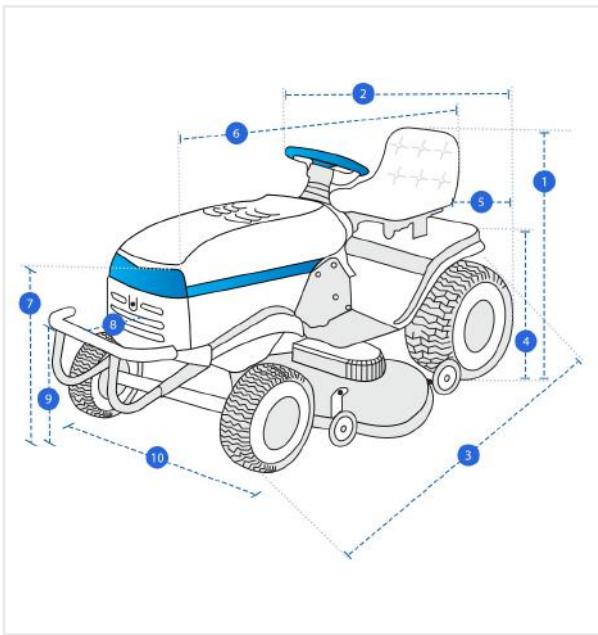

Measurement (Inches)

- | | | | |
|---------------------------------------|----------------------|--------------------------------------|----------------------|
| 1. Back Height | <input type="text"/> | 2. Back Width | <input type="text"/> |
| 3. Total Depth | <input type="text"/> | 4. Height#1 | <input type="text"/> |
| 5. Width Between Seat and Corner | <input type="text"/> | 6. Depth From Bonnet To Seat | <input type="text"/> |
| 7. Height From Ground To Bonnet | <input type="text"/> | 8. Depth From Bumper Guard To Bonnet | <input type="text"/> |
| 9. Height From Ground To Bumper Guard | <input type="text"/> | 10. Front Width | <input type="text"/> |

1. Back Height:
Back Height of the Tractor

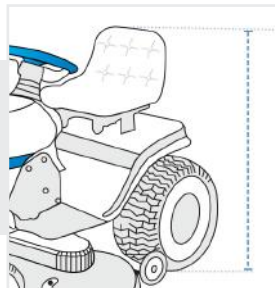

2. Back Width:
Back Width of the Tractor

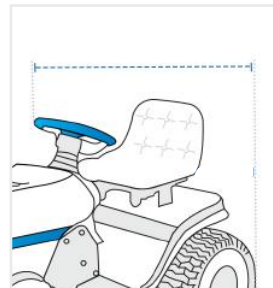

3. Total Depth:
Total Depth of the Tractor

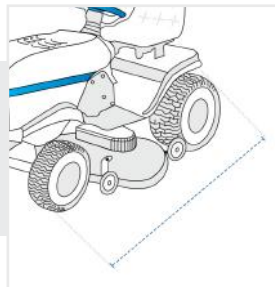

4. Height#1:
Height (Side #1)

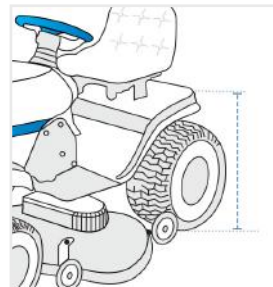

5. Width Between Seat and Corner:
Width Between Seat and Corner of the Tractor

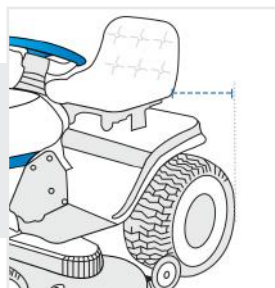

6. Depth From Bonnet To Seat:
Depth From Bonnet To Seat of the Tractor

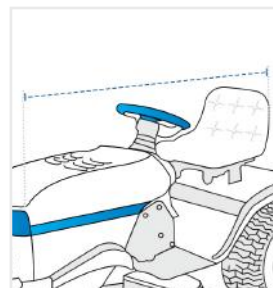

7. Height From Ground To Bonnet:

Height From Ground To Bonnet of the Tractor

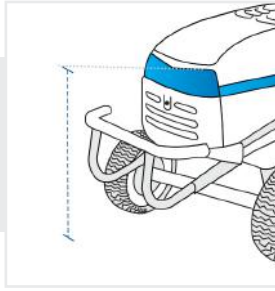

8. Depth From Bumper Guard To Bonnet:

Depth From Bumper Guard To Bonnet of the Tractor

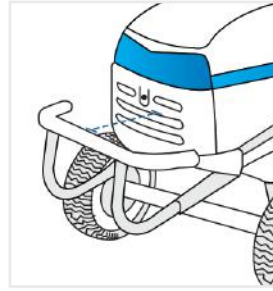

9. Height From Ground To Bumper Guard:

Height From Ground To Bumper Guard of the Tractor

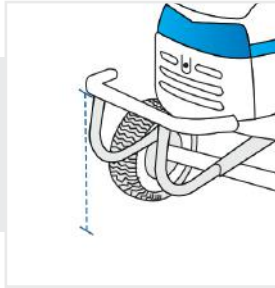

10. Front Width:

Front Width of the Tractor

